

KLT-Z8MA-OV5640-1B V1.0

5MP OmniVision OV5640-1B MIPI-Schnittstelle Autofokus Kameramodul



Vorderansicht



Rückansicht

Spezifikationen

Kameramodul Nr.	KLT-Z8MA-OV5640-1B V1.0
Auflösung	5MP
Bildsensor	OV5640-1B
Sensorart	1/4"
Pixel Größe	1.4 um x 1.4 um
EFL	3.29 mm
F.NO	2.80
Pixel	2592 x 1944
Betrachtungswinkel	68.7°(DFOV) 58.1°(HFOV) 45.0°(VFOV)
Linsenabmessungen	8.50 x 8.50 x 5.07 mm
Modulgröße	36.25 x 10.00 mm
Modultyp	Autofokus
Schnittstelle	MIPI
Autofokus-VCM-Treiber-IC	Eingebettet
Linsenmodell	KLT-LENS-M5101
Linsentyp	650 nm IR-Schnitt
Betriebstemperatur	-30°C to +70°C
Gegenstecker	AXK724147G

KLT-Z8MA-OV5640-1B V1.0**5MP OmniVision OV5640-1B MIPI-Schnittstelle Autofokus Kameramodul**

Ansicht von oben

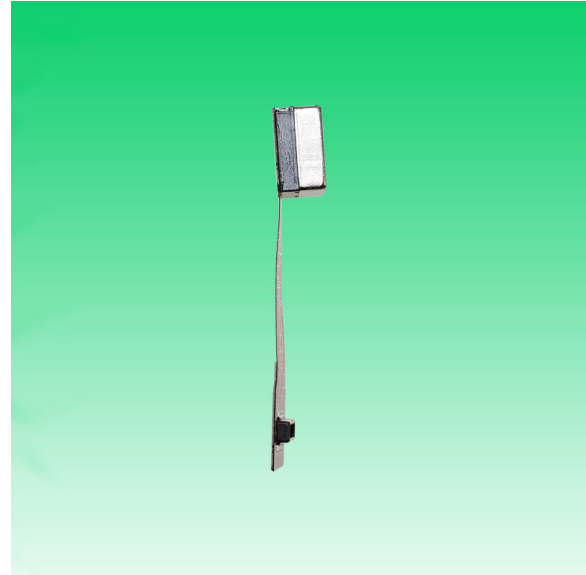

Seitenansicht



Untersicht

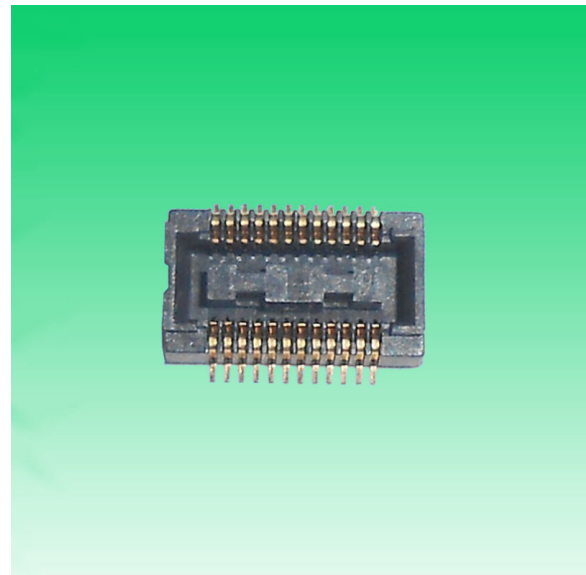

Gegenstecker

A

B

C

D

E

RoHS

PIN	SIGNAL
1	STROBE
2	AGND
3	SDA
4	AVDD 2.8V
5	SCL
6	RESET
7	NC
8	PWDN
9	NC
10	DVDD 1.5V
11	DOVDD 1.8V
12	MDP1
13	XCLK
14	MDN1
15	DGND
16	MCP
17	NC
18	MCN
19	NC
20	MDP0
21	NC
22	MDN0
23	AFVDD 2.8V
24	AF-GND

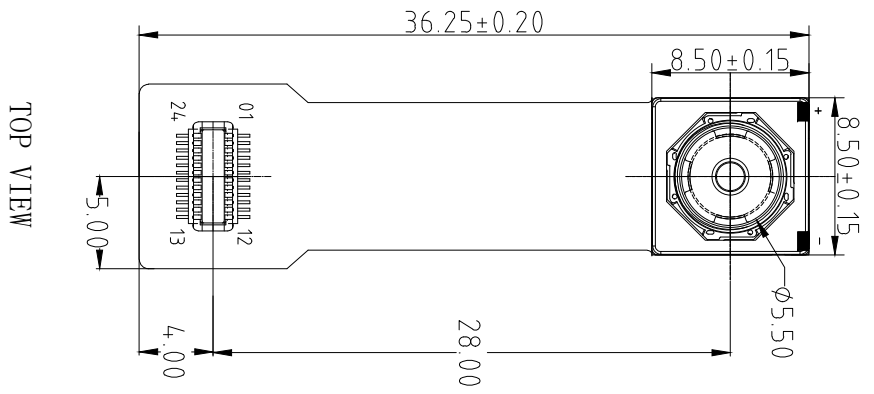
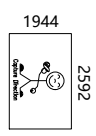

TOP VIEW

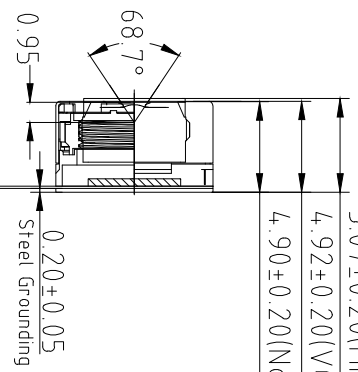

SIDE VIEW

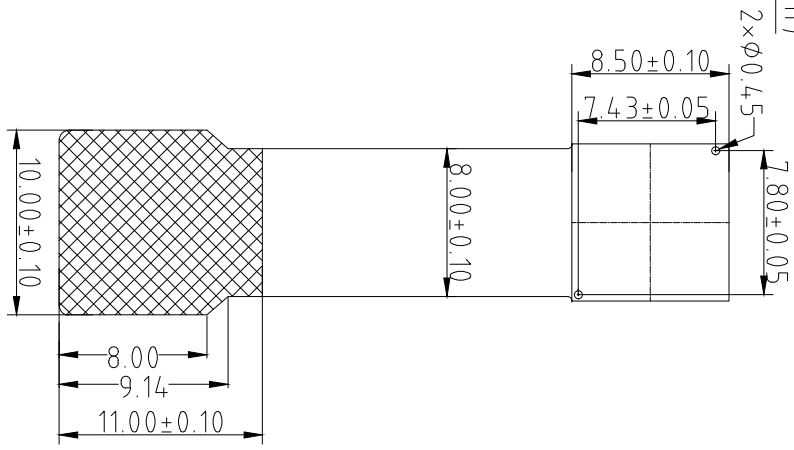

BOTTOM VIEW

Parameters:

1、Sensor specification:

Image Sensor: 0V5640-1B
 Pixel: 1.4um×1.4um
 Lens Type: 1/4
 Important Voltage Description: DVDD1.5V (external power supply);

2、Lens specification:

FOV: 68.7°(D);58.1°(H);4.5°(V)
 F/NO.: 2.8
 TV distortion: <1.0%
 Focal length: 3.29mm
 Composition: 4P+IR FILTER
 IR Cut Coating: 650nm±10nm@50%

Kai Lap Technologies Group Ltd

Version	Information	Date
V1.0	First Version	8-22-2022

Designed By	Kevin	Model Name:	KLT-Z8MA-0V5640-1B V1.0		
Checked By	Aouly Yan	Projection Type:	Unit:	Material:	
		Third Angle	mm		
			Scale:	Sheet:	Version:
			1:1	1 of 1	1/0

A

B

C

D

E

3

2

1

3

2

1



Lens Model: KLT-LENS-M5101

SPECIFICATION		
1. SENSOR SIZE	1/4" (5M CSP)	
2. MAX IMAGE CIRCLE	24.90mm	
3. TOTAL TRACK	4.18±0.1mm	
4. BFL	3.29mm	
5. OPTICAL BFL	1.43mm	
6. MECHANICAL BFL	0.85mm	
7. F/NO	2.8±5%	
8. VIEW OR FIELD	VERTICAL	45.0° (V=1.38)
	HORIZONTAL	58.1° (H=1.814)
	DIAGONAL	68.7° (D=2.268)
9. OPTICAL DISTORTION	<1.0%	
10. TV DISTORTION	<1.0%	
11. RELATIVE ILLUMINATION	>42.3%	
12. CONSTRUCTION	4P+IR FILTER	
13. CHIEF RAY ANGLE	<25°	
14. CUT FREQUENCY AT 50%	650±10nm	
15. THREAD	M6.0X0.35P	
16. IMAGE QUALITY	AXIS	330Lp/mm
	0.7Y	200Lp/mm
17. APPEARANCE QUALITY (Scratch/Dig)	CENTER	20/10
	EDGE	40/20

NO	MODIFY CONTENT	NAME	DATE
4			
3			
2			
1			

ANGLE	RANGE	DIM	UNIT	MATERIAL	SCALE
	ANGLE	±0.5°			8 : 1
	ANGLE	±0.010			
	ANGLE	±0.05			
	ANGLE	±0.1			

NOTE:

- 镜头表面不可有油污、灰尘、毛丝等异物。
- 镜头配VCM锁附高度为 4.7±0.1mm, 扭力为20--60gf.cm。
- 镜头承受推力为≥2.0kg。
- 镜头品质参数需符合图中要求。

Panasonic
ideas for life

**NARROW-PITCH
CONNECTORS FOR
BOARD-TO-BOARD
AND BOARD-TO-FPC
CONNECTION**

**NARROW PITCH
(0.4mm) CONNECTORS
P4 SERIES**



• Without retention fitting

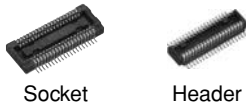

• With retention fitting

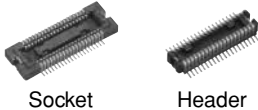

FEATURES

1. 0.4 mm pitch and support for mated heights of up to 1.5 mm, 2.0 mm, 2.5 mm, 3.0 mm, 3.5 mm, and 4.0 mm.

2. Strong resistance to adverse environments! Utilizes **TOUGH CONTACT** construction for high contact reliability.

1) Contacts are highly resistant to shock caused by dropping and employ our original bellows contact construction.

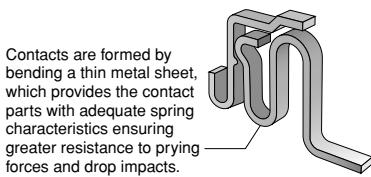

Contacts are formed by bending a thin metal sheet, which provides the contact parts with adequate spring characteristics ensuring greater resistance to prying forces and drop impacts.

2) V notch construction used for excellent resistance against foreign matters.

● What is V notch construction?

By using the edge for the contacting part and increasing contact pressure per unit area, the effectiveness in removing flux and contaminants is increased compared to its predecessor. This is also effective in preventing the trapping of contaminants.

[Cross section of contacting part]

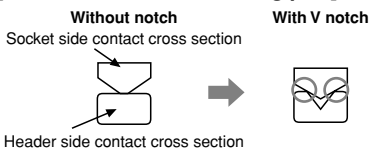

3) Use of Ni barrier construction is standard. Highly effective against solder creeping.

● What is Ni barrier construction?

By providing an exposed nickel part on the gold (Au) plated contact, solder creeping is prevented despite the ultra low profile.

[Contact]

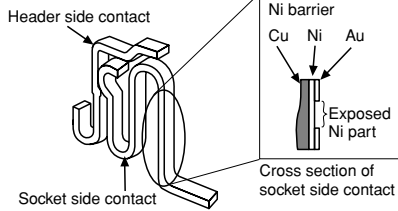

Note: Construction makes solder creeping difficult because header side is formed at the same time.

4) Porosity treatment applied for improved resistance against corrosion.

What is porosity treatment?

This treatment consists of coating the surface with a very thin film to seal pinholes in the gold plating. This porosity treatment technology ensures the same contact reliability for thin gold plating as that of thick gold plating.

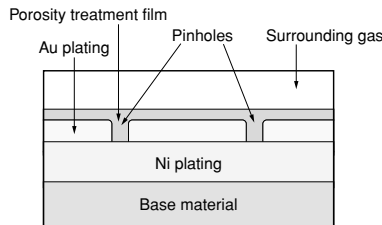

- Improvement in insertion/removal durability
- Improvement in resistance to corrosion
- Improvement in contact reliability for digital signals

3. It is constructed with impact dispersion keys inside the body to disperse shocks when dropped.

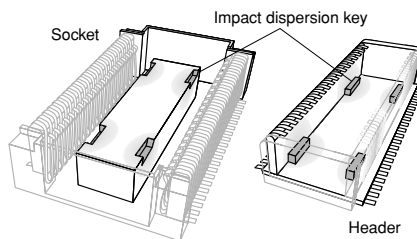

A high level of shock resistance is ensured by dispersing impact over the four locations where the socket indentations and header protrusions are mated together.

Note: The following numbers of contacts are not supported due to suction surface factors.

- Without retention fitting: 18 contacts or less
 - With retention fitting: 22 contacts or less
4. Construction makes designing devices easier.

1) The lower connector bottom surface construction prevents contact and shorts between the PCB and metal terminals. This enables freedom in pattern wiring, helping to make PCB's smaller.

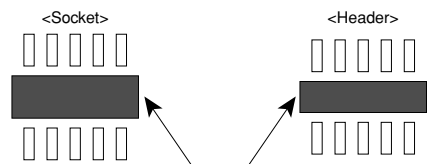

Connector bottom: Create any thru-hole and pattern wiring.

2) Guides are provided to take up any position shift and facilitate insertion.

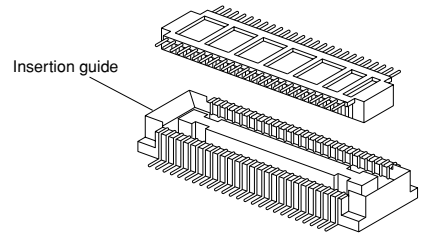

3) The connector has a simple lock mechanism. Superior mated operation with click feel to indicate that mated is complete.

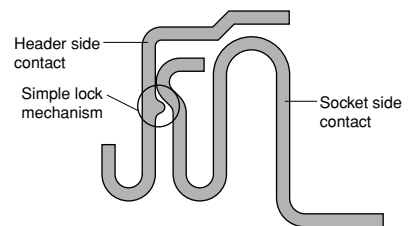

5. Design makes efficient mounting. Features a terminal flatness of 0.08 mm, construction resistant to creeping flux, and design that facilitates visual inspection of the soldered part.

6. Compliance with RoHS Directive Environmentally friendly, the connectors comply with Europe's RoHS Directive. Cadmium, lead, mercury, hexavalent chromium, PBB and PBDE are not used.

7. Connectors for inspection available Connectors for inspection are available that are ideal for modular unit inspection and inspection in device assembly processes.

APPLICATIONS

Compact portable devices “Cellular phones, DVC, Digital cameras, etc”

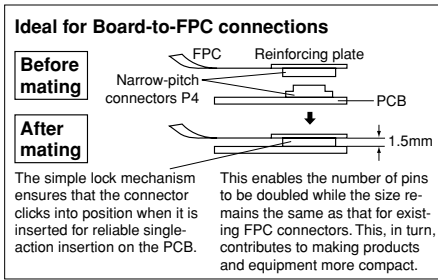
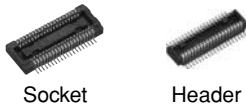

TABLE OF PRODUCT TYPES

P4 (0.4 mm pitch): Without retention fitting



☆: Available for sale

Mated height	Number of contacts						
	1.5mm	2.0mm	2.5mm	3.0mm	3.5mm	4.0mm	
14	☆	☆	☆				
16	☆						
20	☆	☆	☆				
22	☆						
24	☆	☆	☆				
26	☆	☆					
28	☆						
30	☆	☆	☆				
34	☆	☆					
36	☆						
40	☆	☆	☆				
44	☆		☆				
50	☆	☆	☆				
54	☆						
60	☆		☆				
64	☆						
70	☆	☆	☆				
80	☆	☆					
90	☆		☆				
100	☆	☆	☆				

P4 (0.4 mm pitch): With retention fitting

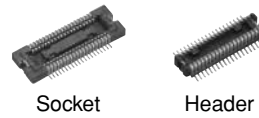

☆: Available for sale

Mated height	Number of contacts						
	1.5mm	2.0mm	2.5mm	3.0mm	3.5mm	4.0mm	
10	☆						
12	☆						
20	☆		☆	☆	☆		
22	☆						
24		☆					
28	☆						
30	☆						
32			☆				
34	☆					☆	
40	☆		☆	☆			
44	☆						
46	☆						
50	☆		☆	☆	☆	☆	
60	☆		☆	☆	☆		
80	☆	☆	☆	☆	☆	☆	
90	☆		☆	☆			
100	☆						

Note: Please contact us regarding numbers of contacts other than those given above.

AXK7, 8

ORDERING INFORMATION

AXK

7: Narrow Pitch Connector P4 (0.4 mm pitch) Socket
8: Narrow Pitch Connector P4 (0.4 mm pitch) Header

Number of contacts (2 digits)

Mated height
<Socket>
1: For mated height 1.5 mm
2: For mated height 2.0 mm
3: For mated height 2.5 mm and 3.0 mm
4: For mated height 3.5 mm
5: For mated height 4.0 mm
<Header>
1: For mated height 1.5 mm, 2.0 mm and 2.5 mm
2: For mated height 3.0 mm, 3.5 mm and 4.0 mm

Functions
1: With retention fitting, with positioning bosses
2: With retention fitting, without positioning bosses
3: Without retention fitting, with positioning bosses
4: Without retention fitting, without positioning bosses

Surface treatment (Contact portion / Terminal portion)
<Socket>
5: Ni plating on base, Au plating on surface
7: Ni plating on base, Au plating on surface (for Ni barrier product available)
<Header>
5: Ni plating on base, Au plating on surface

Other specifications
<Header>
Y: V notch type product
W: V notch and post edge horseshoe bend type product Note*

Packing
G: 3,000 pieces embossed tape and plastic reel × 2*

Note:
The post edge horseshoe bend indicated by the "W" in the tenth digit of the header part number refers to a construction that makes it difficult for the header post edge to deform when the connector is inserted and removed at an angle.

* Only a socket of mated height 3.5 mm and 4.0 mm: 2,000 pieces embossed tape and plastic reel × 2.

PRODUCT TYPES

1. Without retention fitting 

Mated height	Number of contacts	Part number			Packing	
		Socket	Header		Inner carton	Outer carton
		<i>TOUGH CONTACT</i>	<i>TOUGH CONTACT</i>	<i>TOUGH CONTACT</i> and Post edge horseshoe bend type (Recommendation)		
1.5 mm	14	AXK714147G	AXK814145YG	AXK814145WG	3,000 pieces	6,000 pieces
	16	AXK716147G	AXK816145YG	AXK816145WG		
	20	AXK720147G	AXK820145YG	AXK820145WG		
	22	AXK722147G	AXK822145YG	AXK822145WG		
	24	AXK724147G	AXK824145YG	AXK824145WG		
	26	AXK726147G	AXK826145YG	AXK826145WG		
	28	AXK728147G	AXK828145YG	AXK828145WG		
	30	AXK730147G	AXK830145YG	AXK830145WG		
	34	AXK734147G	AXK834145YG	AXK834145WG		
	36	AXK736147G	AXK836145YG	AXK836145WG		
	40	AXK740147G	AXK840145YG	AXK840145WG		
	44	AXK744147G	AXK844145YG	AXK844145WG		
	50	AXK750147G	AXK850145YG	AXK850145WG		
	54	AXK754147G	AXK854145YG	AXK854145WG		
	60	AXK760147G	AXK860145YG	AXK860145WG		
	64	AXK764147G	AXK864145YG	AXK864145WG		
	70	AXK770147G	AXK870145YG	AXK870145WG		
	80	AXK780147G	AXK880145YG	AXK880145WG		
90	AXK790147G	AXK890145YG	AXK890145WG			
100	AXK700147G	AXK800145YG	AXK800145WG			
2.0 mm	14	AXK714247G	AXK814145YG	AXK814145WG	3,000 pieces	6,000 pieces
	20	AXK720247G	AXK820145YG	AXK820145WG		
	24	AXK724247G	AXK824145YG	AXK824145WG		
	26	AXK726247G	AXK826145YG	AXK826145WG		
	30	AXK730247G	AXK830145YG	AXK830145WG		
	34	AXK734247G	AXK834145YG	AXK834145WG		
	40	AXK740247G	AXK840145YG	AXK840145WG		
	50	AXK750247G	AXK850145YG	AXK850145WG		
	70	AXK770247G	AXK870145YG	AXK870145WG		
	100	AXK700247G	AXK800145YG	AXK800145WG		
2.5 mm	14	AXK714347G	AXK814145YG	AXK814145WG	3,000 pieces	6,000 pieces
	20	AXK720347G	AXK820145YG	AXK820145WG		
	24	AXK724347G	AXK824145YG	AXK824145WG		
	30	AXK730347G	AXK830145YG	AXK830145WG		
	40	AXK740347G	AXK840145YG	AXK840145WG		
	44	AXK744347G	AXK844145YG	AXK844145WG		
	50	AXK750347G	AXK850145YG	AXK850145WG		
	60	AXK760347G	AXK860145YG	AXK860145WG		
	70	AXK770347G	AXK870145YG	AXK870145WG		
	90	AXK790347G	AXK890145YG	AXK890145WG		
100	AXK700347G	AXK800145YG	AXK800145WG			

- Notes: 1. Regarding ordering units; During production: Please make orders in 1-reel units.
 Samples for mounting confirmation: Available in units of 50 pieces. Please consult us. (See "Regarding sample orders to confirm proper mounting" on page 13.)
 Samples: Small lot orders are possible.
2. The standard type comes without positioning bosses. Connectors with positioning bosses are available on-demand production. For this type of connector, 8th digit of the part number changes from 4 to 3. e.g. Mated height 1.5 mm and 20 contacts for socket without retention fitting: AXK720137G
3. The 10th digit "Y" in the header part number indicates the connector has V notch. (For details, please refer to page 36.)
 "W" indicates a product with V notch and post edge horseshoe bend. ("Post edge horseshoe bend" refers to a construction that makes it difficult for the header post edge to deform when the connector is inserted and removed at an angle.)
 "Products with V notch" and "products with V notch and post edge horseshoe bend" are mating compatible.
4. Connectors of different mated height (3.0 mm, 3.5 mm and 4.0 mm) and different number of contacts are available on-demand production only. Please contact us for more details.

SPECIFICATIONS

1. Characteristics

	Item	Specifications	Conditions
Electrical characteristics	Rated current	0.3A/contact (Max. 5 A at total contacts)	
	Rated voltage	60V AC/DC	
	Breakdown voltage	150V AC for 1 min.	Detection current: 1mA
	Insulation resistance	Min. 1,000M Ω (initial)	Using 250V DC megger (applied for 1 min.)
	Contact resistance	Max. 70m Ω	Measured based on the HP4338B measurement method of JIS C 5402
Mechanical characteristics	Composite insertion force	Max. 0.981N {100gf}/contacts \times contacts (initial)	
	Composite removal force	Min. 0.0588N {6gf}/contacts \times contacts (Mated height 1.5 mm, without removal and retention fitting) Min. 0.118N {12gf}/contacts \times contacts (Mated height 1.5 mm, except without removal and retention fitting)	
	Post holding force	Min. 0.981N {100gf}/contacts	Measures the maximum load in the post axial direction until removal
Environmental characteristics	Ambient temperature	-55°C to +85°C	No freezing at low temperatures
	Soldering heat resistance	Max. peak temperature of 245°C	Infrared reflow soldering
		300°C within 5 sec. 350°C within 3 sec.	Soldering iron
	Thermal shock resistance (header and socket mated)	5 cycles, insulation resistance min. 100M Ω , contact resistance max. 70m Ω	Sequence 1. -55 \pm 3°C, 30 minutes 2. ~, Max. 5 minutes 3. 85 \pm 3°C, 30 minutes 4. ~, Max. 5 minutes
	Humidity resistance (header and socket mated)	120 hours, insulation resistance min. 100M Ω , contact resistance max. 70m Ω	Bath temperature 40 \pm 2°C, humidity 90 to 95% R.H.
	Saltwater spray resistance (header and socket mated)	24 hours, insulation resistance min. 100M Ω , contact resistance max. 70m Ω	Bath temperature 35 \pm 2°C, saltwater concentration 5 \pm 1%
Lifetime characteristics	Insertion and removal life	50 times	Repeated insertion and removal speed of max. 200 times/hours

2. Material and surface treatment

Part name	Material	Surface treatment
Molded portion	Heat-resistant resin (UL94V-0), Black	—
Contact and Post	Copper alloy	Contact portion: Ni plating on base, Au plating on surface Terminal portion: Ni plating on base, Au plating on surface (Except for thick of terminal) However, upper terminal of Ni barrier production: Exposed over Ni The area adjacent to the terminal of the sockets on models with Ni barrier is exposed to Ni on base.
Retention fitting portion	Copper alloy	Ni plating on base, Sn plating on surface (Except for front terminal)

AXK7, 8

DIMENSIONS (mm)

1. Without Retention Fitting

Socket (Mated height: 1.5 mm, 2.0 mm, and 2.5 mm)

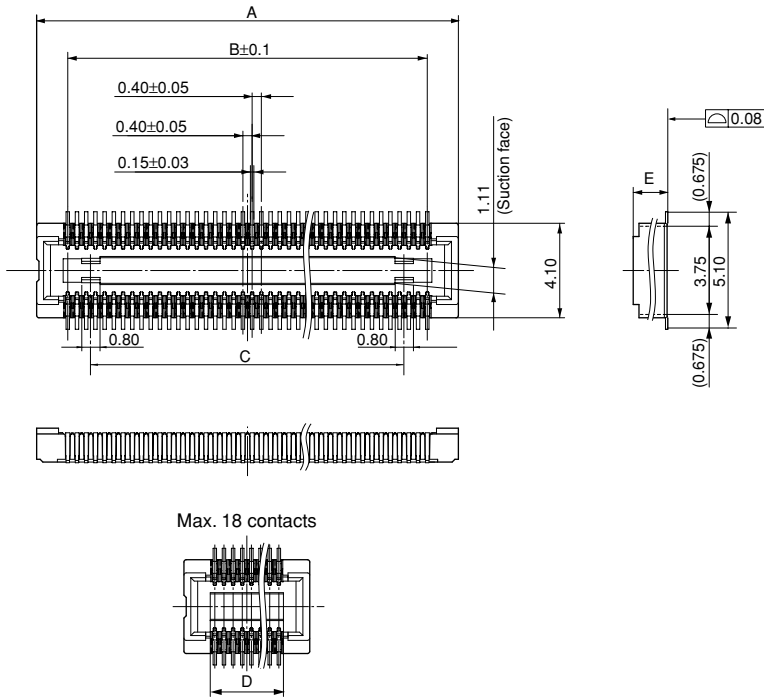

General tolerance: ± 0.2

Dimension table (mm)

Number of contacts/ dimension	A	B	C	D
14	5.1	2.4	—	2.8
16	5.5	2.8	—	3.2
20	6.3	3.6	1.6	—
22	6.7	4.0	2.0	—
24	7.1	4.4	2.4	—
26	7.5	4.8	2.8	—
28	7.9	5.2	3.2	—
30	8.3	5.6	3.6	—
34	9.1	6.4	4.4	—
36	9.5	6.8	4.8	—
40	10.3	7.6	5.6	—
44	11.1	8.4	6.4	—
50	12.3	9.6	7.6	—
54	13.1	10.4	8.4	—
60	14.3	11.6	9.6	—
64	15.1	12.4	10.4	—
70	16.3	13.6	11.6	—
80	18.3	15.6	13.6	—
90	20.3	17.6	15.6	—
100	22.3	19.6	17.6	—

Mated height/dimension	E
1.5mm	1.50
2.0mm	1.92
2.5mm	2.42

Header (Mated height: 1.5 mm, 2.0 mm, and 2.5 mm "products with V notch")

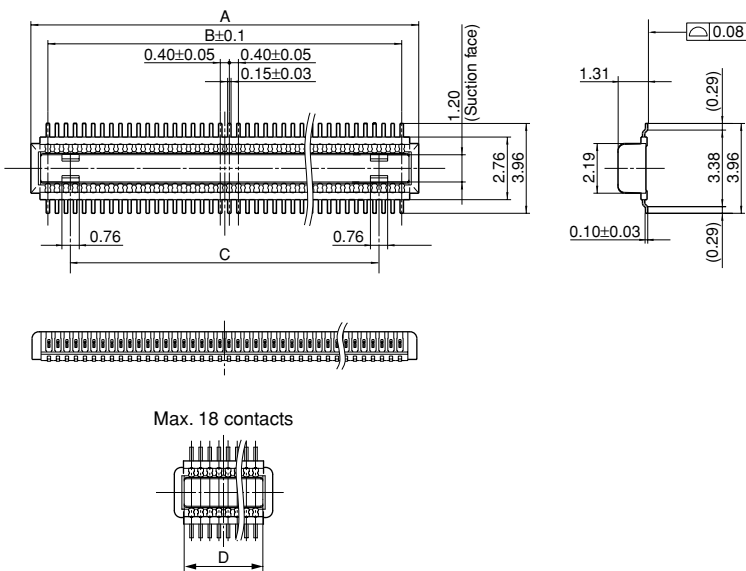

General tolerance: ± 0.2

Dimension table (mm)

Number of contacts/ dimension	A	B	C	D
14	3.9	2.4	—	3.04
16	4.3	2.8	—	3.44
20	5.1	3.6	1.6	—
22	5.5	4.0	2.0	—
24	5.9	4.4	2.4	—
26	6.3	4.8	2.8	—
28	6.7	5.2	3.2	—
30	7.1	5.6	3.6	—
34	7.9	6.4	4.4	—
36	8.3	6.8	4.8	—
40	9.1	7.6	5.6	—
44	9.9	8.4	6.4	—
50	11.1	9.6	7.6	—
54	11.9	10.4	8.4	—
60	13.1	11.6	9.6	—
64	13.9	12.4	10.4	—
70	15.1	13.6	11.6	—
80	17.1	15.6	13.6	—
90	19.1	17.6	15.6	—
100	21.1	19.6	17.6	—

Note: "Products with V notch" and "products with V notch and post edge horseshoe bend" are mating compatible.

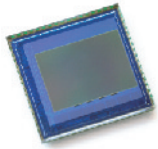

OV5640 5-megapixel product brief



1/4-inch, 5-Megapixel SOC Image Sensor Optimized for High-Volume Mobile Markets



available in
a lead-free
package

The OV5640 delivers a complete 5-megapixel camera solution on a single chip, aimed at offering cost efficiencies that serve the high-volume autofocus (AF) camera phone market. The system-on-a-chip (SOC) sensor features OmniVision's 1.4 micron OmniBSI™ backside illumination architecture to deliver excellent pixel performance and best-in-class low-light sensitivity, while enabling ultra compact camera module designs of 8.5 mm x 8.5 mm with <6 mm z-height. The OV5640 provides the full functionality of a complete camera, including anti-shake technology, AF control, and MIPI while being easier to tune than two-chip solutions, making it an ideal choice in terms of cost, time-to-market and ease of platform integration.

The OV5640 enables 720p HD video at 60 frames per second (fps) and 1080p HD video at 30 fps with complete user control over formatting and output data transfer. The 720p/60 HD video is captured in full field of view (FOV) with 2 x 2 binning, which doubles the sensitivity and improves the signal-to-noise ratio (SNR). Additionally, a unique post-binning re-sampling filter function removes zigzag artifacts around slant edges and minimizes spatial artifacts to deliver even sharper, crisper

color images. To further improve camera performance and user experience, the OV5640 features an internal anti-shake engine for image stabilization, and it supports Scalado™ tagging for faster image preview and zoom.

The OV5640 offers a digital video port (DVP) parallel interface and a high-speed dual lane MIPI interface, supporting multiple output formats. An integrated JPEG compression engine simplifies data transfer for bandwidth-limited interfaces. The sensor's automatic image control functions include automatic exposure control (AEC), automatic white balance (AWB), automatic band filter (ABF), 50/60 Hz automatic luminance detection, and automatic black level calibration (ABLC). The OV5640 delivers programmable controls for frame rate, AEC/AGC 16-zone size/position/weight control, mirror and flip, cropping, windowing, and panning. It also offers color saturation, hue, gamma, sharpness (edge enhancement), lens correction, defective pixel canceling, and noise canceling to improve image quality.

Find out more at www.ovt.com.

applications

- cellular phones
- toys
- PC multimedia
- digital still cameras

ordering information

- **OV05640-A71A-1B** (color, lead-free)
71-pin CSP

features

- 1.4 μm x 1.4 μm pixel with OmniBSI technology for high performance (high sensitivity, low crosstalk, low noise, improved quantum efficiency)
- optical size of 1/4"
- automatic image control functions: automatic exposure control (AEC), automatic white balance (AWB), automatic band filter (ABF), automatic 50/60 Hz luminance detection, and automatic black level calibration (ABLC)
- programmable controls for frame rate, AEC/AGC 16-zone size/position/weight control, mirror and flip, cropping, windowing, and panning
- image quality controls: color saturation, hue, gamma, sharpness (edge enhancement), lens correction, defective pixel canceling, and noise canceling
- support for output formats: RAW RGB, RGB565/555/444, CCIR656, YUV422/420, YCbCr422, and compression
- support for video or snapshot operations
- support for internal and external frame synchronization for frame exposure mode
- support for LED and flash strobe mode
- support for horizontal and vertical sub-sampling, binning
- support for minimizing artifacts on binned image
- support for data compression output
- support for anti-shake
- standard serial SCCB interface
- digital video port (DVP) parallel output interface and dual lane MIPI output interface
- embedded 1.5V regulator for core power
- programmable I/O drive capability, I/O tri-state configurability
- support for black sun cancellation
- support for images sizes: 5 megapixel, and any arbitrary size scaling down from 5 megapixel
- support for auto focus control (AFC) with embedded AF VCM driver
- embedded microcontroller
- suitable for module size of 8.5 x 8.5 x <6mm with both CSP and RW packaging

key specifications (typical)

- **active array size:** 2592 x 1944
- **power supply:**
 - core: 1.425 ~ 1.675V (with embedded 1.5V regulator)
 - analog: 2.6 ~ 3.0V (2.8V typical)
 - I/O: 1.8V / 2.8V
- **power requirements:**
 - active: 140 mA
 - standby: 20 μA
- **temperature range:**
 - operating: -30°C to 70°C junction temperature (see [table 8-2](#))
 - stable image: 0°C to 50°C junction temperature (see [table 8-2](#))
- **output formats:** 8-/10-bit RGB RAW output
- **lens size:** 1/4"
- **lens chief ray angle:** 24° (see [figure 10-2](#))
- **input clock frequency:** 6~27 MHz
- **max S/N ratio:** 36 dB
- **dynamic range:** 68 dB @ 8x gain
- **maximum image transfer rate:**
 - QSXGA (2592x1944): 15 fps
 - 1080p: 30 fps
 - 1280x960: 45 fps
 - 720p: 60 fps
 - VGA (640x480): 90 fps
- **sensitivity:** 600 mV/Lux-sec
- **shutter:** rolling shutter / frame exposure
- **maximum exposure interval:** 1964 x t_{ROW}
- **pixel size:** 1.4 μm x 1.4 μm
- **dark current:** 8 mV/s @ 60°C junction temperature
- **image area:** 3673.6 μm x 2738.4 μm
- **package dimensions:** 5985 μm x 5835 μm



Kameraanwendungen

your BEST camera module partner



Autopilot



Live-Streaming



Videokonferenz



Biometrische Eye-Tracker-Erkennung



Maschinelles Sehen



Agrarmonitor



Nachtsichtsicherheit



Drohnen- und Sport-Adleraugen



Interaktive Haustierkamera

www.KaiLapTech.com sales@KaiLapTech.com Tel: (852) 6908 1256 Fax: (852) 3017 6778



your BEST camera module partner

Kameraanwendungen



IMAGING DEVICES





Referenztable für die Pinbelegungsdefinition des Kameramoduls

OmniVision Sony Himax Samsung On-Semi Aptina Himax GalaxyCore PixArt Bildsensoren	
Pin Signal	Beschreibung
DGND GND	Masse für digitale Schaltung
AGND	Masse für analoge Schaltung
PCLK DCK	DVP-PCLK-Ausgang
XCLR PWDN XSHUTDOWN STANDBY	Abschalten aktiv hoch mit internem Pulldown-Widerstand
MCLK XVCLK XCLK INCK	Systemeingangsuhr
RESET RST	Aktiv Low mit internem Pull-up-Widerstand zurücksetzen
NC NULL	keine Verbindung
SDA SIO_D SIOD	SCCB-Daten
SCL SIO_C SOIC	SCCB-Eingangstakt
VSYNC XVS FSYNC	DVP-VSYNC-Ausgang
HREF XHS	DVP-HREF-Ausgang
DOVDD	Strom für E/A-Schaltung
AFVDD	Strom für VCM-Schaltung
AVDD	Strom für analoge Schaltung
DVDD	Strom für digitale Schaltung
STROBE FSTROBE	Strobe-Ausgang
FSIN	Synchronisieren Sie das VSYNC-Signal vom anderen Sensor
SID	SCCB letzte Bit-ID-Eingabe
ILPWM	mechanische Shutter-Ausgangsanzeige
FREX	Rahmenbelichtung / mechanischer Verschluss
GPIO	Allzweckeingänge
SLASEL	I2C-Slave-Adresse auswählen
AFEN	CEN-Chip aktivieren aktiv hoch auf VCM-Treiber-IC
MIPI Schnittstelle	
MDN0 DN0 MD0N DATA_N DMO1N	MIPI 1st negative Ausgabe der Datenspur
MDP0 DP0 MD0P DATA_P DMO1P	MIPI 1st positiver Ausgang der Datenspur
MDN1 DN1 MD1N DATA2_N DMO2N	MIPI 2nd negative Ausgabe der Datenspur
MDP1 DP1 MD1P DATA2_P DMO2P	MIPI 2nd positiver Ausgang der Datenspur
MDN2 DN2 MD2N DATA3_N DMO3N	MIPI 3rd negative Ausgabe der Datenspur
MDP2 DP2 MD2P DATA3_P DMO3P	MIPI 3rd positiver Ausgang der Datenspur
MDN3 DN3 MD3N DATA4_N DMO4N	MIPI 4th negative Ausgabe der Datenspur
MDP3 DP3 MD3P DATA4_P DMO4P	MIPI 4th positiver Ausgang der Datenspur
MCN CLKN CLK_N DCKN	MIPI Uhr negativer Ausgang
MCP CLKP MCP CLK_P DCKN	MIPI Takt positiver Ausgang
DVP Parallel Schnittstelle	
D0 DO0 Y0	DVP Datenausgabeport 0
D1 DO1 Y1	DVP Datenausgabeport 1
D2 DO2 Y2	DVP Datenausgabeport 2
D3 DO3 Y3	DVP Datenausgabeport 3
D4 DO4 Y4	DVP Datenausgabeport 4
D5 DO5 Y5	DVP Datenausgabeport 5
D6 DO6 Y6	DVP Datenausgabeport 6
D7 DO7 Y7	DVP Datenausgabeport 7
D8 DO8 Y8	DVP Datenausgabeport 8
D9 DO9 Y9	DVP Datenausgabeport 9
D10 DO10 Y10	DVP Datenausgabeport 10
D11 DO11 Y11	DVP Datenausgabeport 11



Kamera-Zuverlässigkeitstest

Reliability Inspection Item		Testmethode	Akzeptanzkriterium	
Kategorie	Artikel			
Umwelt	Lager Temperatur	Hoch 60°C 96 Std	Temperaturkammer	Keine anormale Situation
		Niedrig -20°C 96 Std	Temperaturkammer	Keine anormale Situation
	Betriebs Temperatur	Hoch 60°C 24 Std	Temperaturkammer	Keine anormale Situation
		Niedrig -20°C 24 Std	Temperaturkammer	Keine anormale Situation
	Feuchtigkeit	60°C 80% 24 Std	Temperaturkammer	Keine anormale Situation
Thermischer Schock	Hoch 60°C 0.5 Std Niedrig -20°C 0.5 Std Radfahren rein 24 Std	Temperaturkammer	Keine anormale Situation	
Physisch	Falltest (Im freien Fall)	Ohne Verpackung 60cm	10 Mal auf Holzboden	Elektrisch funktionsfähig
		Mit Paket 60cm	10 Mal auf Holzboden	Elektrisch funktionsfähig
	Vibrations Test	50Hz X-Axis 2mm 30 Minuten	Vibrationstisch	Elektrisch funktionsfähig
		50Hz Y-Axis 2mm 30 Minuten	Vibrationstisch	Elektrisch funktionsfähig
		50Hz Z-Axis 2mm 30 Minuten	Vibrationstisch	Elektrisch funktionsfähig
Zugfestigkeit des Kabels Krafttest	Gewicht laden 4 kg 60 Sekunden Radfahren rein 24 Std	Zugprüfmaschine	Elektrisch funktionsfähig	
Elektrisch	ESD-Test	Kontaktaufnahme 2 KV	ESD-Prüfmaschine	Elektrisch funktionsfähig
		Luftentladung 4 KV	ESD-Prüfmaschine	Elektrisch funktionsfähig
	Alterungstest	On/Off 30 Sekunden Radfahren rein 24 Std	Stromschalter	Elektrisch funktionsfähig
	USB-Anschluss	On/Off 250 Mal	Einstecken und ausstecken	Elektrisch funktionsfähig





Inspektionsgegenstand		Untersuchungsmethode	Inspektionsstandard	
Kategorie	Artikel			
Aussehen	FPC oder PCB	Farbe	Das bloße Auge	Größere Unterschiede sind nicht zulässig.
		Zerrissen/gehackt werden	Das bloße Auge	Das Freilegen von Kupferrissen ist nicht zulässig.
		Markierung	Das bloße Auge	Klar, erkennbar (innerhalb von 30 cm Entfernung)
	Halterin	Kratzer	Das bloße Auge	Die Freilegung von Rissen im Inneren ist nicht zulässig
		Lücke	Das bloße Auge	Erfüllen Sie den Höhenstandard
		Schraube	Das bloße Auge	Stellen Sie sicher, dass Schrauben vorhanden sind (falls vorhanden)
		Schaden	Das bloße Auge	Die Freilegung von Rissen im Inneren ist nicht zulässig
	Linse	Kratzen	Das bloße Auge	Keine Auswirkung auf den Auflösungsstandard
		Kontamination	Das bloße Auge	Keine Auswirkung auf den Auflösungsstandard
		Ölfilm	Das bloße Auge	Keine Auswirkung auf den Auflösungsstandard
		Abdeckband	Das bloße Auge	Kein Problem beim Aussehen.
	Funktion	Bild	Keine Kommunikation	Testboard
Helles Pixel			Tafel	Im Image Center nicht erlaubt
Dunkles Pixel			Weißer Tafel	Im Image Center nicht erlaubt
Verschwommen			Das bloße Auge	Nicht erlaubt
Kein Bild			Das bloße Auge	Nicht erlaubt
Vertikale Linie			Das bloße Auge	Nicht erlaubt
Horizontale Linie			Das bloße Auge	Nicht erlaubt
Kleines Leck			Das bloße Auge	Nicht erlaubt
Blinkendes Bild			Das bloße Auge	Nicht erlaubt
Prellung			Inspektionslehre	Nicht erlaubt
Auflösung			Diagramm	Folgt dem Diagrammstandard für ausgehende Inspektionen
Farbe			Das bloße Auge	Kein Problem
Lärm			Das bloße Auge	Nicht erlaubt
Ecke dunkel			Das bloße Auge	Weniger als 100 x 100 Pixel
Farbauflösung			Das bloße Auge	Kein Problem
Abmessungen	Höhe	Das bloße Auge	Follows Approval Data Sheet	
	Breite	Das bloße Auge	Follows Approval Data Sheet	
	Länge	Das bloße Auge	Follows Approval Data Sheet	
	Gesamt	Das bloße Auge	Follows Approval Data Sheet	



KLT-Paketlösungen

KLT Kameramodul



Komplett mit Linsenschutzfolie



Tablett mit Gitter und Raum



Legen Sie die Kameras auf das Tablett



Paketlösung für Kameramodule

Volles Tablett mit Kameras



Abdeckschale mit Deckel



In Antistatikbeutel stecken



Staubsaugen Sie den antistatischen Beutel





Paketlösung für Kameramodule

Versiegelter Vakuumbbeutel mit Etiketten

1. Modell und Beschreibung 2. Menge 3. Versanddatum 4. Achtung



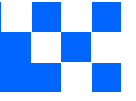

Paketlösung für große Bestellungen

Schaumstoffplatten zwischen
die Tablettts legen



Schaumstoffplatten sind etwas
größer als Tablettts



Legen Sie Schaumstoffplatten und
Tablettts in die Schachtel



Schaumstoffplatten sind eng anliegende Box





Paketlösung für kleine Bestellungen

Legen Sie die Schaumstoffplatten und
Tablets in die kleine Schachtel



Schaumstoffplatten passen gut in
die kleine Box



Paket in kleiner Box für den Versand



Legen Sie kleine Kartons in größere Kartons





Carbon Box Paketlösung

Verschließen Sie die Carbonbox

Beschriftete Schachtel mit Endverpackung



Versandfertige Karbonbox

1. Lieferadresse und Telefonnummer
2. Box-Nr. und Versanddatum
3. Zerbrechliche Vorsicht



Lösung für Musterbestellungspakete

Legen Sie die Probe in einen kleinen antistatischen Beutel



Stecken Sie die Anschlüsse in den kleinen antistatischen Beutel



Musteretiketten auf dem kleinen Beutel

1. Kameramodul oder Anschlussmodell 2. Lieferdatum und Menge 3. Achtung





Connectors Large Order Package Solution

Steckverbinder in einem Rad



Steckverbinder im Rad beschriften



Das Rad passt perfekt in die Box



Steckerbox versandfertig



Unternehmen Kai Lap Technologies (KLT)

Kai Lap Technologies Group Limited. (KLT) wurde 2009 gegründet und ist ein technologiegetriebener Hersteller der nächsten Generation, der sich auf Forschung, Design und Produktion von Audio- und Videoprodukten spezialisiert hat. KLT verfügt über 20.000 Quadratfuß automatisierte Fabriken mit 100 Mitarbeitern und einem jährlichen Durchsatz von 30.000.000 Kameraeinheiten.

KLT bietet OEM-, ODM-Design, Auftragsfertigung und baut die Kameraprodukte. Sie können uns die Anforderungen auch mit einem Handentwurf übermitteln, unser Vertrieb und unsere Technik arbeiten zusammen, um Ihre Anforderungen zu erfüllen. Wir verstehen uns als Ihr langfristiger Partner bei der Entwicklung praktischer und innovativer Lösungen.

Unser Team deckt alles von der ersten Konzeptentwicklung bis zum Massenprodukt ab. KLT ist spezialisiert auf kundenspezifisches Kameradesign, Rohmaterial, Elektrotechnik, Firmware-/Softwareentwicklung, Produkttests und Verpackungsdesign. Unsere erfahrenen strategischen Versorgungssysteme bieten eine robuste und zuverlässige Fertigungskapazität für Aufträge unterschiedlicher Größe.

**Eingeschränkte Garantie**

KLT gewährt die folgende eingeschränkte Garantie, wenn Sie das/die Produkt(e) direkt von der Firma KLT oder von der Website von KLT, www.KaiLapTech.com, gekauft haben. Produkte, die von anderen Verkäufern oder Quellen gekauft wurden, fallen nicht unter diese beschränkte Garantie. KLT garantiert, dass das/die Produkt(e) bei normalem Gebrauch für einen Zeitraum von einem (1) Jahr ab dem Datum, an dem Sie das Produkt erhalten („Garanzzeitraum“), frei von Material- und Verarbeitungsfehlern sind.

Für alle Produkte, die während des Garanzzeitraums Material- oder Verarbeitungsfehler enthalten oder entwickeln, wird KLT nach eigenem Ermessen entweder: (i) die Produkte reparieren; (ii) das/die Produkt(e) durch ein neues oder generalüberholtes Produkt(e) ersetzen (Ersatzprodukt(e) sind von identischem Modell oder funktionell gleichwertig); oder (iii) Ihnen den Preis erstatten, den Sie für das/die Produkt(e) gezahlt haben.

Diese eingeschränkte Garantie von KLT ist ausschließlich auf Reparatur und/oder Ersatz zu den oben genannten Bedingungen beschränkt. KLT ist nicht zuverlässig oder verantwortlich für nachfolgende Ereignisse.





CMOS CAMERA MODULES



your BEST camera module partner

KLT Stärke

Leistungsstarke Fabrik



Professioneller Service



Versprochene Lieferung



www.KaiLapTech.com sales@KaiLapTech.com Tel: (852) 6908 1256 Fax: (852) 3017 6778

All rights reserved @ Kai Lap Technologies Group Ltd. Specifications subject to change without notice.